















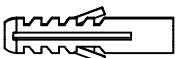

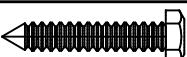

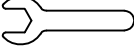
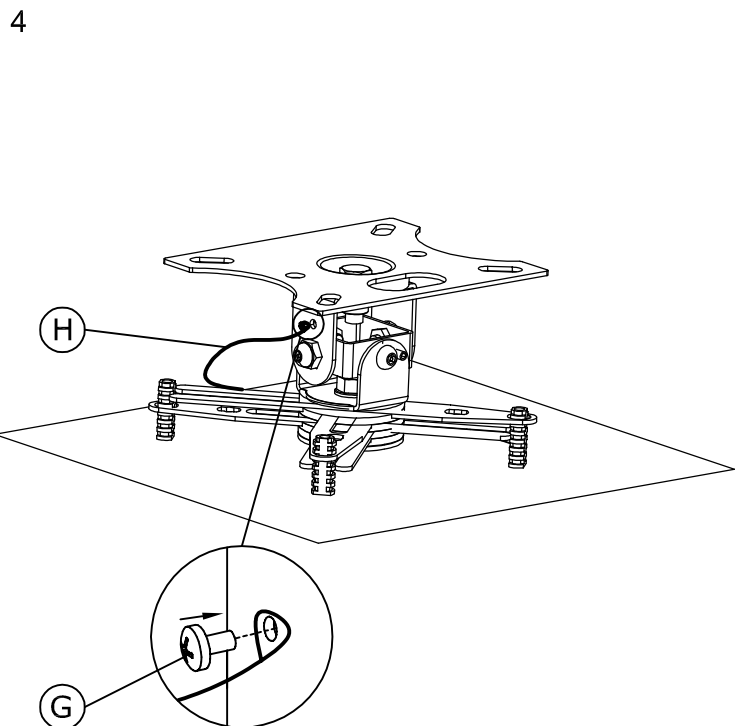
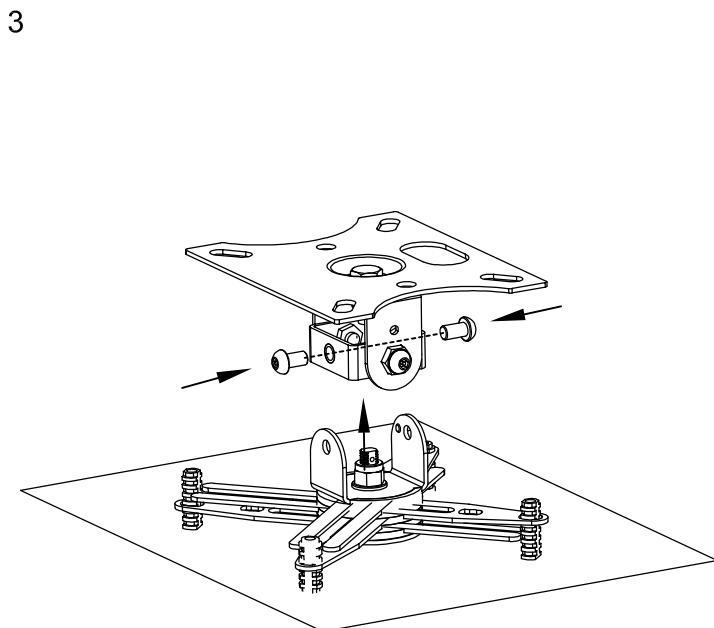
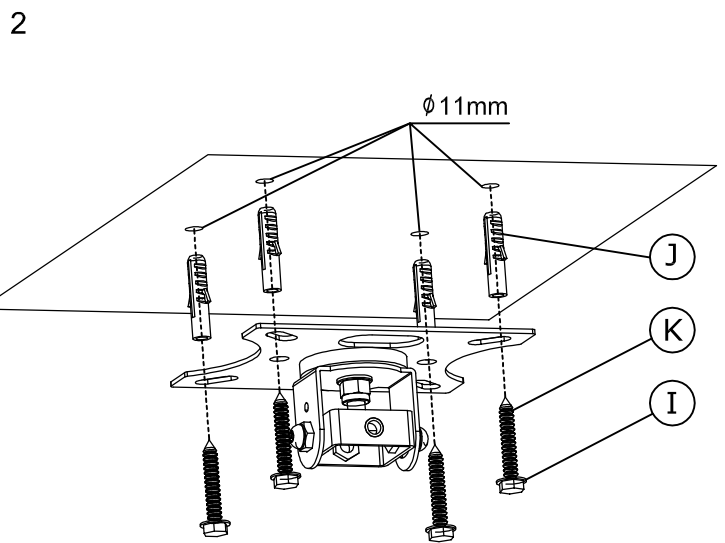
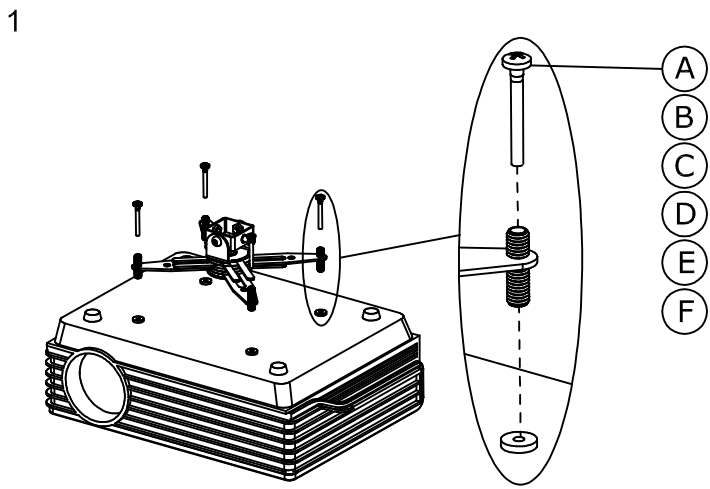



# TM-CC

(A)	M2.5×40mm		×4	(G)	M6×8mm		×1
(B)	M3×40mm		×4	(H)			
(C)	M4×40mm		×4	(I)	∅8		×4
(D)	M5×40mm		×4	(J)	∅10×50mm		×4
(E)	M6×40mm		×4	(K)	ST8×45mm		×4
(F)			×4	(L)		 	



# TM-CC

(A)	M2.5×40mm		×4	(G)	M6×8mm		×1
(B)	M3×40mm		×4	(H)			
(C)	M4×40mm		×4	(I)	∅8		×4
(D)	M5×40mm		×4	(J)	∅10×50mm		×4
(E)	M6×40mm		×4	(K)	ST8×45mm		×4
(F)			×4	(L)		