

TM-CC OWNERS MANUAL



www.visionaudiovisual.com/techmount/tm-cc

DECLARATION OF CONFORMITY

Where applicable Vision products are certified and comply with all known local regulations to a 'CB Certification' standard. Vision commits to ensure all products are fully compliant with all applicable certification standards for sale in the EU and other participating countries.

The product described in this owner manual is in compliance with RoHS (EU directive 2002/95/EC), and WEEE (EU directive 2002/96/EC) standards. This product should be returned to the place of purchase at the end of its useful life for recycling.

WARNINGS

During installation take care to adhere to workplace health and safety laws:

- Attach the bracket to a rated load-bearing structure.



NEVER MOUNT BRACKET DIRECTLY TO A FALSE CEILING!

- Do not cut or drill any parts above head height. This should all be done using the correct safety equipment at floor level.
- Avoid overstretching which might result in the ladder tipping over.
- SWL (safe working load): 10kg
- Ensure it is installed in an appropriate place – for example not obstructing an emergency exit.
- Ensure it is at least 2000mm above the ground to prevent accidental injury.
- Check stability after installation.
- Installation must be done by a specialist audio-visual installer
- Avoid installing in a moist environment, or in direct sunshine, or near corrosive gas or liquid.
- Routing of cables through the bracket must comply with local regulations.



ENSURE POWER CABLE IS NOT TWISTED, SQUEEZED, OR SHEARED!











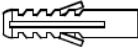

All products are designed and imported into the EU by 'Vision' who is wholly owned by 'Azlan Logistics Ltd.', Registered in England Nr. 04625566 at Lion House, 4 Pioneer Business Park, Clifton Moor, York, YO30 4GH. WEEE Registration: GD0046SY

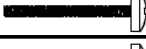
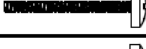

DECLARATION OF ORIGIN

All Vision products are made in the People's Republic of China (PRC).

ACCESSORIES

| | | | |
|-----|-----------|---|----|
| (A) | φ10x50mm |  | x4 |
| (B) | ST8x45mm |  | x4 |
| (C) | φ8 |  | x4 |
| (D) | M8x16mm |  | x4 |
| (G) | M6x8mm |  | x1 |
| (I) | M2.5x40mm |  | x4 |
| (J) | M3x40mm |  | x4 |
| (K) | M4x40mm |  | x4 |
| (L) | M5x40mm |  | x4 |
| (M) | M6x40mm |  | x4 |
| (N) | |  | x4 |
| (O) | |  | x1 |
| (P) | |  | x1 |
| (Q) | |  | x1 |

Sleeve for M2.5 screw

BRACKET PARTS

1. Ceiling Plate
2. Top "U"
3. Square Section
4. Bottom "U"
5. Universal "Spider"

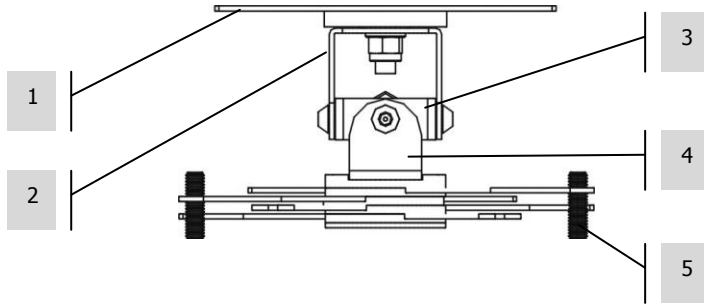

INSTALLATION

1. FIX CEILING PLATE TO CEILING



Ensure the correct fixtures are used to attach the Techmount to the wall or ceiling. The fixtures provided are ST8x50 bolts with 10mm plastic inserts for attachment to masonry. They may not be suitable for your application.

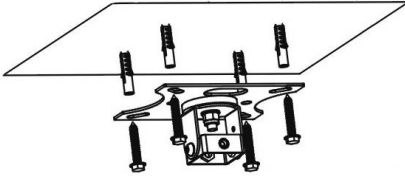

2. ATTACH MOUNT TO PROJECTOR Attach spider to projector.

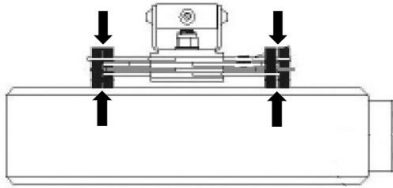

3. ATTACH ASSEMBLY TO CEILING PLATE Fix projector assembly to ceiling plate.

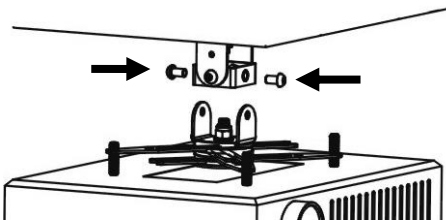

1. FIT SAFETY CABLE Add fall-arrest cable to pole and projector.

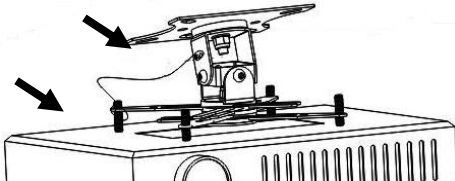

SPECIFICATIONS

OVERALL LENGTH: 100 mm

SAFE WORKING LOAD: 10kg

COLOUR: Satin White

COMPLIANCE: TUV-GS

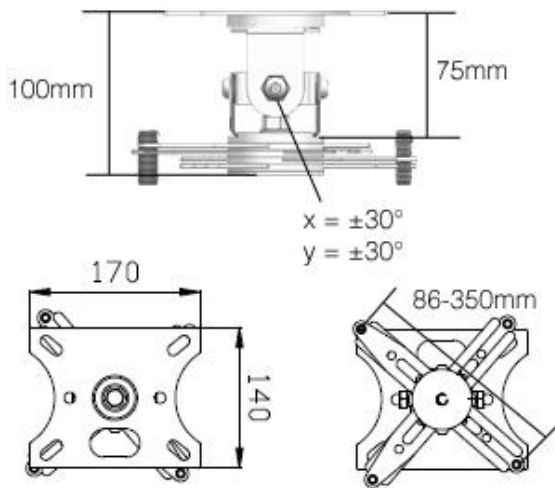

CEILING PLATE DIMENSIONS

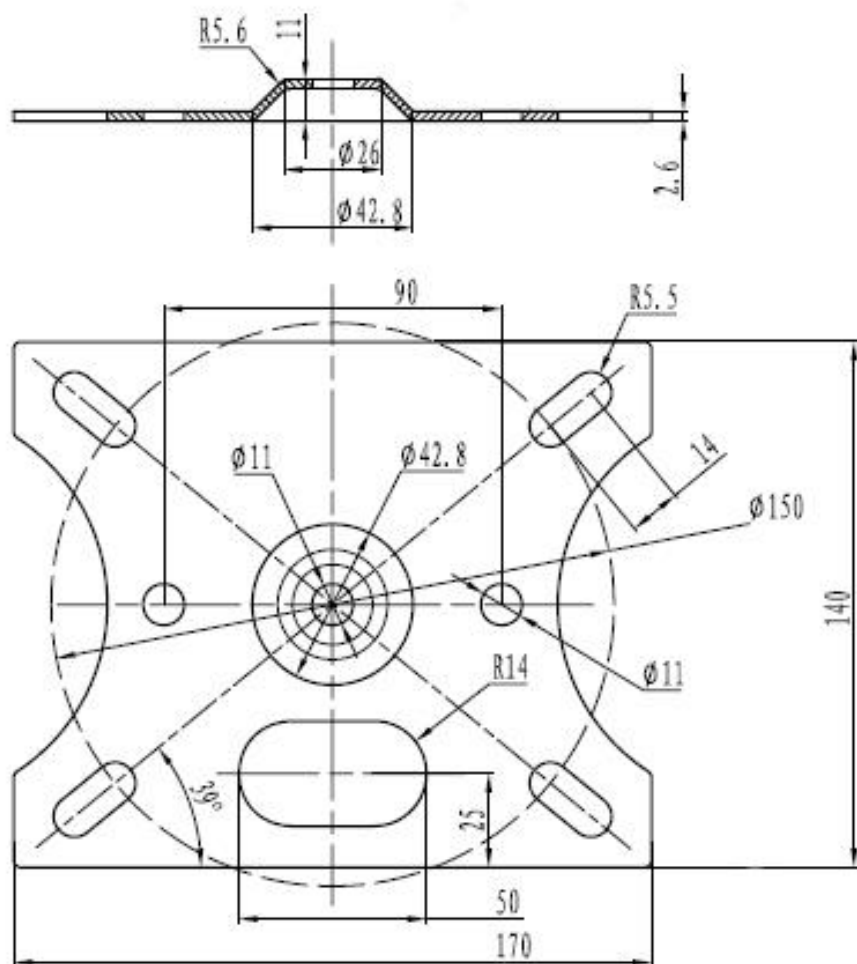

LIFETIME RETURN-TO-BASE WARRANTY

This product comes with a lifetime return to base warranty. If you have a problem you are required to provide a DETAILED DESCRIPTION of the fault.

Some Vision products are very technical and require troubleshooting all elements of the installation as it may not be the Vision product at fault. Because of this the manufacturer may refuse to replace the item if an adequate description is not provided.

- This warranty applies only to the original purchaser and is not transferable.
- This warranty protects you against the following:
 - Failure of any components, including the power supply.
 - Damage when the product is first removed from its packaging if reported within 24 hours of purchase.
- If the product is DOA (dead on arrival), you have 21 days from purchase date to notify the national distributor via your AV reseller.
- The original purchaser is responsible for shipment of the product to the Vision's appointed service centre.
- The liability of Vision is limited to the cost of replacement of the faulty unit under warranty except for death or injury (EU85/374/EEC).
- If the product is end of line (EOL) the Vision will provide a credit instead of replacement.
- This warranty does not protect this product against faults caused by abuse, misuse, incorrect installation, unstable or faulty power input, or modification.

Vision aims to send a replacement item within 5 working days however this may not always be possible, in which case it will be sent as soon as practicably possible. UK End users and resellers can request support at <http://www.visionaudiovisual.com/support>

2-YEAR ONSITE WARRANTY (UK ONLY)

The manufacturer provides an onsite warranty for the first two years taken from date of sale.

This service can be requested at the url above and is provided at the manufacturer's discretion.

- This service is only provided for products which are difficult for an end user to get at and replace.
- The manufacturer will not provide the onsite service if
 - The reseller or end user has been abusive
 - The user has is taking unfair advantage of this service
- The manufacturer will pre-qualify the visit to ensure the fault relates to the Vision product.

The engineer visits are timed to ensure you are onsite and the room is accessible. A revisit WILL NOT be provided if access to the room is not provided at the arranged time. Engineers will wait 15 minutes only.

LEGAL DISCLAIMER: Because we are committed to improving our products, the details above may change without prior warning. This User Manual is published without warranty and any improvements or changes to the User Manual necessitated by typographical errors, inaccuracies of current information, or improvements to programs and/or equipment, may be made at any time and without notice. Such changes will be incorporated into new editions of the User Manual.